

COMPREHENSIVE SERVICES

We offer competitive repair and calibration services, as well as easily accessible documentation and free downloadable resources.

SELL YOUR SURPLUS

We buy new, used, decommissioned, and surplus parts from every NI series. We work out the best solution to suit your individual needs.

 Sell For Cash  Get Credit  Receive a Trade-In Deal

OBSOLETE NI HARDWARE IN STOCK & READY TO SHIP

We stock **New**, **New Surplus**, **Refurbished**, and **Reconditioned** NI Hardware.



Bridging the gap between the manufacturer and your legacy test system.

 1-800-915-6216

 www.apexwaves.com

 sales@apexwaves.com

All trademarks, brands, and brand names are the property of their respective owners.

Request a Quote

 **CLICK HERE**

SCXI-1348

SCXI-1162HV

User Manual

32-Channel Isolated AC/DC Digital Input Module

August 1994 Edition

Part Number 320790A-01

**© Copyright 1994 National Instruments Corporation.
All Rights Reserved.**

National Instruments Corporate Headquarters

6504 Bridge Point Parkway

Austin, TX 78730-5039

(512) 794-0100

Technical support fax: (800) 328-2203

(512) 794-5678

Branch Offices:

Australia (03) 879 9422, Austria (0662) 435986, Belgium 02/757.00.20, Canada (Ontario) (519) 622-9310,

Canada (Québec) (514) 694-8521, Denmark 45 76 26 00, Finland (90) 527 2321, France (1) 48 14 24 24,

Germany 089/741 31 30, Italy 02/48301892, Japan (03) 3788-1921, Netherlands 03480-33466, Norway 32-848400,

Spain (91) 640 0085, Sweden 08-730 49 70, Switzerland 056/20 51 51, U.K. 0635 523545

Limited Warranty

The SCXI-1162HV is warranted against defects in materials and workmanship for a period of one year from the date of shipment, as evidenced by receipts or other documentation. National Instruments will, at its option, repair or replace equipment that proves to be defective during the warranty period. This warranty includes parts and labor.

A Return Material Authorization (RMA) number must be obtained from the factory and clearly marked on the outside of the package before any equipment will be accepted for warranty work. National Instruments will pay the shipping costs of returning to the owner parts which are covered by warranty.

National Instruments believes that the information in this manual is accurate. The document has been carefully reviewed for technical accuracy. In the event that technical or typographical errors exist, National Instruments reserves the right to make changes to subsequent editions of this document without prior notice to holders of this edition. The reader should consult National Instruments if errors are suspected. In no event shall National Instruments be liable for any damages arising out of or related to this document or the information contained in it.

EXCEPT AS SPECIFIED HEREIN, NATIONAL INSTRUMENTS MAKES NO WARRANTIES, EXPRESS OR IMPLIED, AND SPECIFICALLY DISCLAIMS ANY WARRANTY OF MERCHANTABILITY OR FITNESS FOR A PARTICULAR PURPOSE. CUSTOMER'S RIGHT TO RECOVER DAMAGES CAUSED BY FAULT OR NEGLIGENCE ON THE PART OF NATIONAL INSTRUMENTS SHALL BE LIMITED TO THE AMOUNT THEREFORE PAID BY THE CUSTOMER. NATIONAL INSTRUMENTS WILL NOT BE LIABLE FOR DAMAGES RESULTING FROM LOSS OF DATA, PROFITS, USE OF PRODUCTS, OR INCIDENTAL OR CONSEQUENTIAL DAMAGES, EVEN IF ADVISED OF THE POSSIBILITY THEREOF. This limitation of the liability of National Instruments will apply regardless of the form of action, whether in contract or tort, including negligence. Any action against National Instruments must be brought within one year after the cause of action accrues. National Instruments shall not be liable for any delay in performance due to causes beyond its reasonable control. The warranty provided herein does not cover damages, defects, malfunctions, or service failures caused by owner's failure to follow the National Instruments installation, operation, or maintenance instructions; owner's modification of the product; owner's abuse, misuse, or negligent acts; and power failure or surges, fire, flood, accident, actions of third parties, or other events outside reasonable control.

Copyright

Under the copyright laws, this publication may not be reproduced or transmitted in any form, electronic or mechanical, including photocopying, recording, storing in an information retrieval system, or translating, in whole or in part, without the prior written consent of National Instruments Corporation.

Trademarks

LabVIEW[®], NI-DAQ[®], and RTSI[®] are trademarks of National Instruments Corporation.

Product and company names listed are trademarks or trade names of their respective companies.

Warning Regarding Medical and Clinical Use of National Instruments Products

National Instruments products are not designed with components and testing intended to ensure a level of reliability suitable for use in treatment and diagnosis of humans. Applications of National Instruments products involving medical or clinical treatment can create a potential for accidental injury caused by product failure, or by errors on the part of the user or application designer. Any use or application of National Instruments products for or involving medical or clinical treatment must be performed by properly trained and qualified medical personnel, and all traditional medical safeguards, equipment, and procedures that are appropriate in the particular situation to prevent serious injury or death should always continue to be used when National Instruments products are being used. National Instruments products are NOT intended to be a substitute for any form of established process, procedure, or equipment used to monitor or safeguard human health and safety in medical or clinical treatment.

Contents

| | |
|---|-----|
| About This Manual | vii |
| Organization of This Manual | vii |
| Conventions Used in This Manual..... | vii |
| The National Instruments Documentation Set | ix |
| Related Documentation..... | ix |
| Customer Communication | x |
| | |
| Chapter 1 | |
| Introduction | 1-1 |
| About the SCXI-1162HV..... | 1-1 |
| What You Need to Get Started | 1-1 |
| Software Programming Choices | 1-1 |
| LabVIEW and LabWindows Application Software | 1-2 |
| NI-DAQ Driver Software..... | 1-2 |
| Register-Level Programming..... | 1-4 |
| Optional Equipment | 1-4 |
| Custom Cables | 1-5 |
| Unpacking | 1-6 |
| | |
| Chapter 2 | |
| Configuration and Installation | 2-1 |
| Module Configuration..... | 2-1 |
| Configuration Options..... | 2-1 |
| Configuring the Rear Connector for Parallel Mode..... | 2-2 |
| Configuring the Rear Connector for Serial Mode..... | 2-2 |
| Jumper Use..... | 2-3 |
| Supplementary Jumper W3 Configuration Installation | 2-6 |
| Hardware Installation..... | 2-6 |
| Software Installation | 2-7 |
| | |
| Chapter 3 | |
| Signal Connections | 3-1 |
| Front Connector | 3-3 |
| Front Connector Signal Descriptions..... | 3-4 |
| Input Channels | 3-4 |
| Sensing DC Voltages | 3-4 |
| Sensing AC Voltages | 3-5 |
| Signal Isolation | 3-5 |
| Signal Connection Example..... | 3-5 |
| Terminal Block | 3-6 |
| Rear Signal Connector | 3-6 |
| Rear Signal Connector Signal Descriptions, Serial Configuration | 3-8 |
| Rear Signal Connector Signal Descriptions, Parallel Configuration | 3-9 |

| | |
|-------------------------------------|------------|
| Appendix A | |
| Specifications | A-1 |
| Appendix B | |
| Customer Communication | B-1 |
| Glossary | Glossary-1 |
| Index | Index-1 |

Figures

| | | |
|-------------|---|-----|
| Figure 1-1. | The Relationship between the Programming Environment, NI-DAQ, and Your Hardware..... | 1-3 |
| Figure 2-1. | Removing the SCXI Module Cover..... | 2-3 |
| Figure 2-2. | SCXI-1162HV Parts Locator Diagram | 2-4 |
| Figure 3-1. | SCXI-1162HV Front Connector Pin Assignment..... | 3-3 |
| Figure 3-2. | Signal Connection Example..... | 3-6 |
| Figure 3-3. | SCXI-1162HV Rear Signal Connector Pin Assignments | 3-7 |

Tables

| | | |
|------------|--|-----|
| Table 2-1. | Digital Signal Connections, Jumper Settings..... | 2-5 |
|------------|--|-----|

About This Manual

This manual describes the electrical and mechanical aspects of the SCXI-1162HV and contains information concerning its operation. The SCXI-1162HV is a member of the National Instruments Signal Conditioning eXtensions for Instrumentation (SCXI) Series modules for the National Instruments plug-in DAQ boards. This module switches and controls low-level and power signals. The SCXI-1162HV operates as 32 digital input channels, arranged as eight banks of four channels. Each bank is optically isolated.

Organization of This Manual

The *SCXI-1162HV User Manual* is organized as follows:

- Chapter 1, *Introduction*, describes the SCXI-1162HV; lists what you need to get started with your SCXI-1162HV; describes the software programming choices and optional equipment; and explains how to unpack the SCXI-1162HV kit.
- Chapter 2, *Configuration and Installation*, describes the SCXI-1162HV jumper configurations and installation of the SCXI-1162HV into the SCXI chassis.
- Chapter 3, *Signal Connections*, describes the SCXI-1162HV signal connections via the front and rear connectors, and has specifications and connection instructions for the SCXI-1162HV connector signals.
- Appendix A, *Specifications*, lists the specifications for the SCXI-1162HV.
- Appendix B, *Customer Communication*, contains forms you can use to request help from National Instruments or to comment on our products.
- The *Glossary* contains an alphabetical list and description of terms used in this manual, including abbreviations, acronyms, metric prefixes, mnemonics, and symbols.
- The *Index* contains an alphabetical list of key terms and topics in this manual, including the page where you can find each one.

Conventions Used in This Manual

The following conventions are used in this manual:

| | |
|---------------------------|---|
| <i>bold italic</i> | Bold italic text denotes a note, caution, or warning. |
| DIO board | DIO board refers to the National Instruments AT-DIO-32F, MC-DIO-24, MC-DIO-32F, NB-DIO-24, NB-DIO-96, NB-DIO-32F, PC-DIO-24, and PC-DIO-96 digital I/O DAQ boards unless otherwise noted. |

| | |
|----------------|---|
| DIO-24 board | DIO-24 board refers to the National Instruments MC-DIO-24, NB-DIO-24, and PC-DIO-24 digital I/O DAQ boards. |
| DIO-type board | DIO-type board refers to National Instruments DAQ boards that have only digital inputs and outputs. These boards include the DIO-24, DIO-32F, and DIO-96 boards unless otherwise noted. |
| <i>italic</i> | Italic text denotes emphasis, a cross reference, or an introduction to a key concept. |
| Lab board | Lab board refers to the National Instruments Lab-LC, Lab-NB, Lab-PC, and Lab-PC+ boards unless otherwise noted. |
| MC | MC refers to the Micro Channel Series computers. |
| MIO board | MIO board refers to the National Instruments AT-MIO-16, AT-MIO-16D, AT-MIO-16F-5, AT-MIO-16X, AT-MIO-64F-5, MC-MIO-16, NB-MIO-16, and NB-MIO-16X multichannel I/O DAQ boards unless otherwise noted. |
| MIO-type board | MIO-type board refers to National Instruments DAQ boards that have at least analog and digital inputs and outputs. These boards include the MIO boards, the Lab boards, and the PC-LPM-16 board unless otherwise noted. |
| monospace | Lowercase text in this font denotes text or characters that are to be literally input from the keyboard, sections of code, programming examples, and syntax examples. This font is also used for the proper names of disk drives, paths, directories, programs, subprograms, subroutines, device names, functions, variables, filenames, and extensions, and for statements and comments taken from program code. |
| NB | NB refers to the NuBus Series computers. |
| PC | PC refers to the IBM PC/XT, the IBM PC AT, and compatible computers. |
| SCXIBus | SCXIBus refers to the backplane in the chassis. A signal on the backplane is referred to as the SCXIBus <signal name> line (or signal). The SCXIBus descriptor may be omitted when the meaning is clear. |
| Slot 0 | Slot 0 refers to the power supply and control circuitry in the SCXI chassis. |

Abbreviations, acronyms, metric prefixes, mnemonics, symbols, and terms are listed in the *Glossary*.

The National Instruments Documentation Set

The *SCXI-1162HV User Manual* is one piece of the documentation set for your DAQ or SCXI system. You could have any of several types of manuals, depending on the hardware and software in your system. Use these different types of manuals as follows:

- *Getting Started with SCXI*—If you are using SCXI, this is the first manual you should read. It gives an overview of the SCXI system and contains the most commonly needed information for the modules, chassis, and software.
- Your SCXI hardware user manuals—If you are using SCXI, read these manuals next for detailed information about signal connections and module configuration. They also explain in greater detail how the module works and contain application hints.
- Your DAQ hardware user manuals—These manuals have detailed information about the DAQ hardware that plugs into or is connected to your computer. Use these manuals for hardware installation and configuration instructions, specification information about your DAQ hardware, and application hints.
- Software manuals—Examples of software manuals you may have are the LabVIEW and LabWindows® manual sets and the NI-DAQ manuals. After you have set up your hardware system, use either the application software (LabVIEW or LabWindows) manuals or the NI-DAQ manuals to help you write your application. If you have a large and complicated system, it is worthwhile to look through the software manuals before you configure your hardware.
- Accessory installation guides or manuals—If you are using accessory products, read the terminal block and cable assembly installation guides or accessory board user manuals. They explain how to physically connect the relevant pieces of the system. Consult these guides when you are making your connections.
- SCXI chassis manuals—If you are using SCXI, read these manuals for maintenance information on the chassis and installation instructions.

Related Documentation

In addition, the following National Instruments manual contains detailed information for the register-level programmer.

- *SCXI-1162HV Register-Level Programmer Manual*

This manual is available from National Instruments by request. If you are using NI-DAQ, LabVIEW, or LabWindows, you should not need the register-level programmer manual. Using NI-DAQ, LabVIEW, or LabWindows is quicker and easier than and as flexible as using the low-level programming described in the register-level programmer manual. Refer to *Software Programming Choices* in Chapter 1, *Introduction*, of this manual to learn about your programming options.

Customer Communication

National Instruments wants to receive your comments on our products and manuals. We are interested in the applications you develop with our products, and we want to help if you have problems with them. To make it easy for you to contact us, this manual contains comment and configuration forms for you to complete. These forms are in Appendix B, *Customer Communication*, at the end of this manual.

Chapter 1

Introduction

This chapter describes the SCXI-1162HV; lists what you need to get started with your SCXI-1162HV; describes the software programming choices and optional equipment; and explains how to unpack the SCXI-1162HV kit.

About the SCXI-1162HV

The SCXI-1162HV module consists of 32 optically isolated, wide range, AC or DC digital inputs. The SCXI-1162HV is a module for sensing the presence of AC or DC voltages where high common-mode voltages may be present.

The SCXI-1162HV works with National Instruments MIO Series boards; the SCXI-1200 module; Lab series boards; and with the DIO-24, DIO-32F, and DIO-96 boards. You can read 24 inputs in parallel mode with a DIO-24 board, or all 32 inputs with a DIO-32F or a DIO-96 board. You can also use the SCXI-1162HV in parallel mode with other digital logic inputs that comply with the specifications in Chapter 3, *Signal Connections*. You can control several SCXI-1162HVs in series mode in a single chassis with one DAQ board.

An additional shielded terminal block, the SCXI-1326, has screw terminals for easy signal attachment to the SCXI-1162HV.

With the SCXI-1162HV, the SCXI chassis can serve as a digital signal monitor in laboratory testing, production testing, and industrial process monitoring.

What You Need to Get Started

To set up and use your SCXI-1162HV, you will need the following:

- SCXI-1162HV module
- SCXI-1162HV User Manual*
- SCXI chassis

Software Programming Choices

There are four options to choose from when programming your National Instruments DAQ and SCXI hardware. You can use LabVIEW, LabWindows, NI-DAQ, or register-level programming software.

The SCXI-1162HV works with LabVIEW for Windows, LabVIEW for Macintosh, LabWindows for DOS, LabWindows/CVI for Windows, NI-DAQ software for PC compatibles.

LabVIEW and LabWindows Application Software

LabVIEW and LabWindows are innovative program development software packages for data acquisition and control applications. LabVIEW uses graphical programming, whereas LabWindows enhances traditional programming languages. Both packages include extensive libraries for data acquisition, instrument control, data analysis, and graphical data presentation.

LabVIEW currently runs on three different platforms—AT/MC/EISA computers running Microsoft Windows, the Macintosh platform, and the Sun SPARCstation platform. LabVIEW features interactive graphics, a state-of-the-art user interface, and a powerful graphical programming language. The LabVIEW Data Acquisition VI Library, a series of VIs for using LabVIEW with National Instruments DAQ hardware, is included with LabVIEW. The LabVIEW Data Acquisition VI Libraries are functionally equivalent to the NI-DAQ software, except that the SCXI functions are not included in the LabVIEW software for Sun.

LabWindows has two versions—LabWindows for DOS is for use on PCs running DOS, and LabWindows/CVI is for use on PCs running Windows and for Sun SPARCstations. LabWindows/CVI features interactive graphics, a state-of-the-art user interface, and uses the ANSI standard C programming language. The LabWindows Data Acquisition Library, a series of functions for using LabWindows with National Instruments DAQ hardware, is included with the NI-DAQ software kit. The LabWindows Data Acquisition libraries are functionally equivalent to the NI-DAQ software, except that the SCXI functions are not included in the LabWindows/CVI software for Sun.

Using LabVIEW or LabWindows software will greatly reduce the development time for your data acquisition and control application.

NI-DAQ Driver Software

The NI-DAQ driver software is included at no charge with all National Instruments DAQ hardware. NI-DAQ is not packaged with SCXI or accessory products except for the SCXI-1200. NI-DAQ has an extensive library of functions that you can call from your application programming environment. These functions include routines for analog input (A/D conversion), buffered data acquisition (high-speed A/D conversion), analog output (D/A conversion), waveform generation, digital I/O, counter/timer operations, SCXI, RTSI, self-calibration, messaging, and acquiring data to extended memory.

NI-DAQ also internally addresses many of the complex issues between the computer and the DAQ hardware such as programming interrupts and DMA controllers. NI-DAQ maintains a consistent software interface among its different versions so that you can change platforms with minimal modifications to your code. Figure 1-1 illustrates the relationship between NI-DAQ and LabVIEW and LabWindows. You can see that the data acquisition parts of LabVIEW and LabWindows are functionally equivalent to the NI-DAQ software.

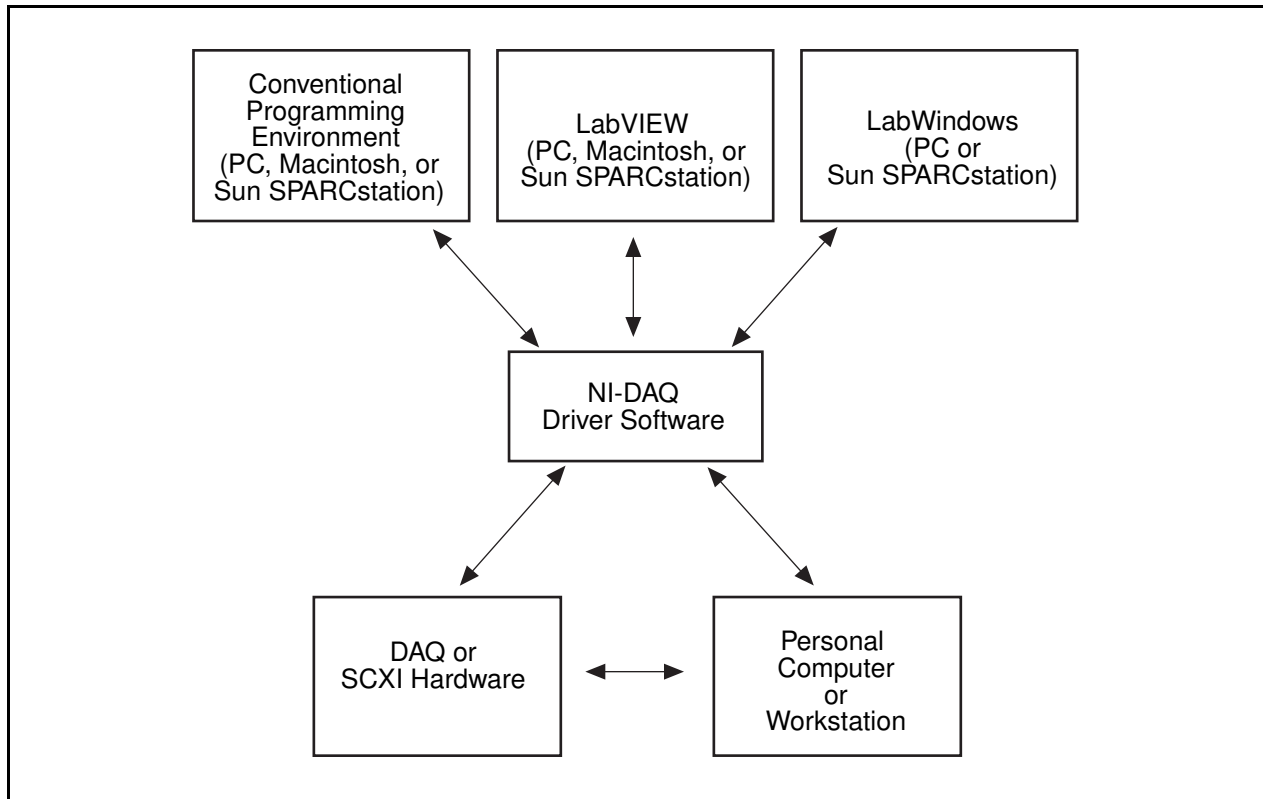

Figure 1-1. The Relationship between the Programming Environment, NI-DAQ, and Your Hardware

The National Instruments PC, AT, MC, EISA, DAQCard, and DAQPad Series DAQ hardware are packaged with NI-DAQ software for PC compatibles. NI-DAQ software for PC compatibles comes with language interfaces for Professional BASIC, Turbo C++, Borland C++, and Microsoft C for DOS; and Visual Basic, Turbo Pascal, Microsoft C with SDK, and Borland C++ for Windows. You can use your SCXI-1163R, together with other PC, AT, MC, DAQCard, and SCXI hardware, with NI-DAQ software for PC compatibles.

The National Instruments NB Series DAQ boards are packaged with NI-DAQ software for Macintosh. NI-DAQ software for Macintosh comes with language interfaces for MPW C, THINK C, Pascal, and Microsoft QuickBASIC. Any language that uses Device Manager Toolbox calls can access NI-DAQ software for Macintosh. You can use NB Series DAQ boards and SCXI hardware with NI-DAQ software for Macintosh.

The National Instruments SB Series DAQ boards are packaged with NI-DAQ software for Sun, which comes with a language interface for ANSI C.

Register-Level Programming

The final option for programming any National Instruments DAQ hardware is to write register-level software. Writing register-level programming software can be very time-consuming and inefficient, and is not recommended for most users. The *only* users who should consider writing register-level software should meet at least one of the following criteria:

- National Instruments does not support your operating system or programming language.
- You are an experienced register-level programmer who is more comfortable writing your own register-level software.

Even if you are an experienced register-level programmer, always consider using NI-DAQ, LabVIEW, or LabWindows to program your National Instruments DAQ hardware. Using the NI-DAQ, LabVIEW, or LabWindows software is easier than, and as flexible as, register-level programming, and can save you weeks of development time.

The *SCXI-1162HV User Manual* and your software manuals contain complete instructions for programming your SCXI-1162HV with NI-DAQ, LabVIEW, or LabWindows. If you are using NI-DAQ, LabVIEW, or LabWindows to control your board, you should not need the register-level programmer manual.

The *SCXI-1162HV Register-Level Programmer Manual* contains low-level programming details, such as register maps, bit descriptions, and register programming hints, that you will need only for register-level programming. If you want to obtain the register-level programmer manual, please fill out the *Register-Level Programmer Manual Request Form* in Appendix B, *Customer Communication*, at the end of this manual and send it to National Instruments.

Optional Equipment

Contact National Instruments to order any of the following optional equipment:

- SCXI-1326 front terminal block
- SCXI-1340 cable assembly
- SCXI-1341 Lab-NB/Lab-PC/Lab-PC+ cable assembly
- SCXI-1342 PC-LPM-16 cable assembly
- SCXI-1343 rear screw terminal adapter
- SCXI-1344 Lab-LC cable assembly
- SCXI-1350 multichassis adapter
- SCXI-1351 one slot extender cable

- SCXI-1348 DIO-32F cable assembly
- Standard ribbon cable in lengths of 0.5 or 1.0 m
- NB5 cable in lengths of 0.5 or 1.0 m

Refer to Chapter 3, *Signal Connections*, and to your cable or accessory installation guide for additional information on cabling, connectors, and adapters.

Custom Cables

The SCXI-1162HV rear signal connector is a 50-pin male ribbon-cable header. The manufacturer part number for the header National Instruments uses is as follows:

- AMP Inc. (part number 1-103310-0)

The mating connector for the SCXI-1162HV rear signal connector is a 50-position polarized ribbon-socket connector with strain relief. National Instruments uses a polarized or keyed connector to prevent inadvertent upside-down connection to the SCXI-1162HV. Recommended manufacturer part numbers for this mating connector are as follows:

- Electronic Products Division/3M (part number 3425-7650)
- T&B/Ansley Corporation (part number 609-5041CE)

Standard 50-conductor 28 AWG stranded ribbon cables that work with these connectors are as follows:

- Electronic Products Division/3M (part number 3365/50)
- T&B/Ansley Corporation (part number 171-50)

The SCXI-1162HV front connector is a special 48-pin DIN C male connector. The manufacturer part number of the connector National Instruments uses is as follows:

- ERNI Components, Inc. (part number 033-273)

The mating connector for the SCXI-1162HV front connector is a special 48-pin reversed DIN C female connector. National Instruments uses a polarized and keyed connector to prevent inadvertent upside-down connection to the SCXI-1162HV. The manufacturer part number of the mating connector National Instruments uses is as follows:

- ERNI Components, Inc. (part number 913-271)

These connectors were selected to meet UL 1244 for 450 Vrms working isolation.

Unpacking

Your SCXI-1162HV module is shipped in an antistatic package to prevent electrostatic damage to the module. Electrostatic discharge can damage several components on the module. To avoid such damage in handling the module, take the following precautions:

- Ground yourself via a grounding strap or by holding a grounded chassis such as an SCXI chassis.
- Touch the antistatic package to a metal part of your SCXI chassis before removing the module from the package.
- Remove the module from the package and inspect the module for loose components or any other sign of damage. Notify National Instruments if the module appears damaged in any way. *Do not* install a damaged module into your SCXI chassis.
- *Never* touch the exposed pins of connectors.

Chapter 2

Configuration and Installation

This chapter describes the SCXI-1162HV jumper configurations and installation of the SCXI-1162HV into the SCXI chassis.

Module Configuration

The SCXI-1162HV has six user-configurable jumpers and one reserved jumper that are shown in the parts locator diagram in Figure 2-1. You use these jumpers to configure the SCXI-1162HV rear connector.

Notes: *When you are controlling the SCXI-1162HV through the SCXIbus and are not using the rear connector (not cabled directly to a plug-in DAQ board), the positions of the configuration jumpers are irrelevant.*

If you want to use a single DAQ board to control a chassis which contains analog modules in addition to your SCXI-1162HV, then you must cable your DAQ board to one of the analog modules rather than to the SCXI-1162HV.

You can configure the SCXI-1162HV rear connector to send data directly from the inputs in parallel, or to form a serial communication link with the SCXIbus. In the latter case, you can also configure the rear connector to connect to a DIO-type or an MIO-type DAQ board.

You must configure the module in the chassis that is cabled to the DAQ board to allow reads from module registers. (Specifically, the module must be configured to send data from the SCXIbus MISO line to the SERDATOUT pin of the module rear connector. Refer to the user manual for the SCXI module you are cabling to a DAQ board for information on how to accomplish this.)

Configuration Options

The SCXI-1162HV is shipped configured for serial communication through a DIO-type board or the SCXI chassis. Change the jumper configuration from the factory default settings *only* if you plan to cable the SCXI-1162HV rear connector to an MIO-type board, or to use the SCXI-1162HV in parallel mode, or if the SCXI-1162HV is a controller module for a multichassis system.

Configuring the Rear Connector for Parallel Mode

When the rear connector is configured for parallel mode, the data from each input is sent directly to a rear connector pin. You do not need serial communication with the SCXI chassis or modules to read the data when the module is in parallel mode. This mode may be useful when you want to send data from the SCXI-1162HV directly to equipment other than a DAQ board.

When the SCXI-1162HV is configured for parallel mode, a DAQ board cabled to the module can only read from that module; communication with the SCXI chassis or other modules in that chassis must be through another DAQ board. Only DIO DAQ boards can read the data from the SCXI-1162HV in parallel mode; MIO boards can only read from the SCXI-1162HV in serial mode.

When you configure the SCXI-1162HV for parallel mode, the module can drive either all 32 digital lines of the rear connector or only the first 24 lines. When you cable a DIO-24 or the DIO portion of an AT-MIO-16D to an SCXI-1162HV in parallel mode, the SCXI-1162HV *must* be configured to drive only 24 of the rear connector lines, because the DIO-24 and the AT-MIO-16D only have 24 digital inputs. *Do not* attempt to connect the SCXI-1162HV to a DIO-24 or an AT-MIO-16D with the module configured to drive all 32 lines in parallel, as this may cause driver contention.

Note: *When the rear connector is configured for parallel mode, the data can still be read in serial mode through the SCXIbus connector. The jumper set configuration only affects the rear signal connector; no other module functionality is affected by the jumper positions.*

Configuring the Rear Connector for Serial Mode

When the rear connector is configured for serial mode, there is a serial data link between the rear connector and the SCXIbus. This lets a DAQ board cabled to the rear connector communicate with the SCXI-1162HV *and* with all other modules in the chassis. This is the recommended mode of operation because you only need one DAQ board for an entire SCXI system.

When the SCXI-1162HV is configured for serial mode, only digital data is transferred between the SCXIbus and the rear signal connector. Thus, in a mixed system of analog modules and digital modules, the DAQ board must be cabled to an analog module. If the DAQ board were cabled to a digital module such as the SCXI-1162HV, the analog signals from analog modules could not reach the DAQ board.

Jumper Use

To configure the SCXI-1162HV module, use the six user-configurable jumpers (W2–W7) shown in the parts locator diagram, Figure 2-2. (Jumper W1 is a reserved jumper and should remain unconnected.) If you are controlling the SCXI-1162HV via the SCXIBus and are not using the rear connector, then the positions of these jumpers are irrelevant. Tables 2-1 and 2-2 list the description and configuration of the user-configurable jumpers. To change the configuration of the module, refer to Figures 2-1 and 2-2 as you perform the following steps:

1. Remove the grounding screw of the top cover.
2. Snap out the top cover of the shield by placing a screwdriver in the groove at the bottom of the module.
3. Remove the jumpers to be changed and replace them on the appropriate pins.
4. Record the new jumper settings on the *SCXI-1162HV Hardware Configuration Form* in Appendix B, *Customer Communication*.
5. Snap the top cover back in place.
6. Replace the grounding screw to ensure proper shielding.

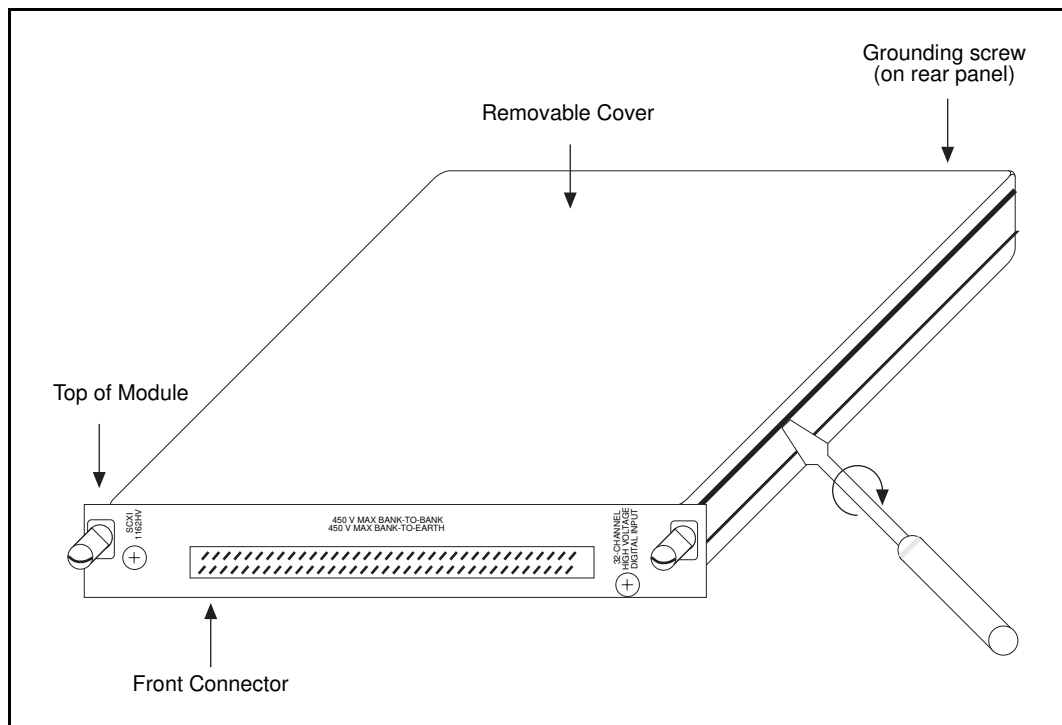

Figure 2-1. Removing the SCXI Module Cover

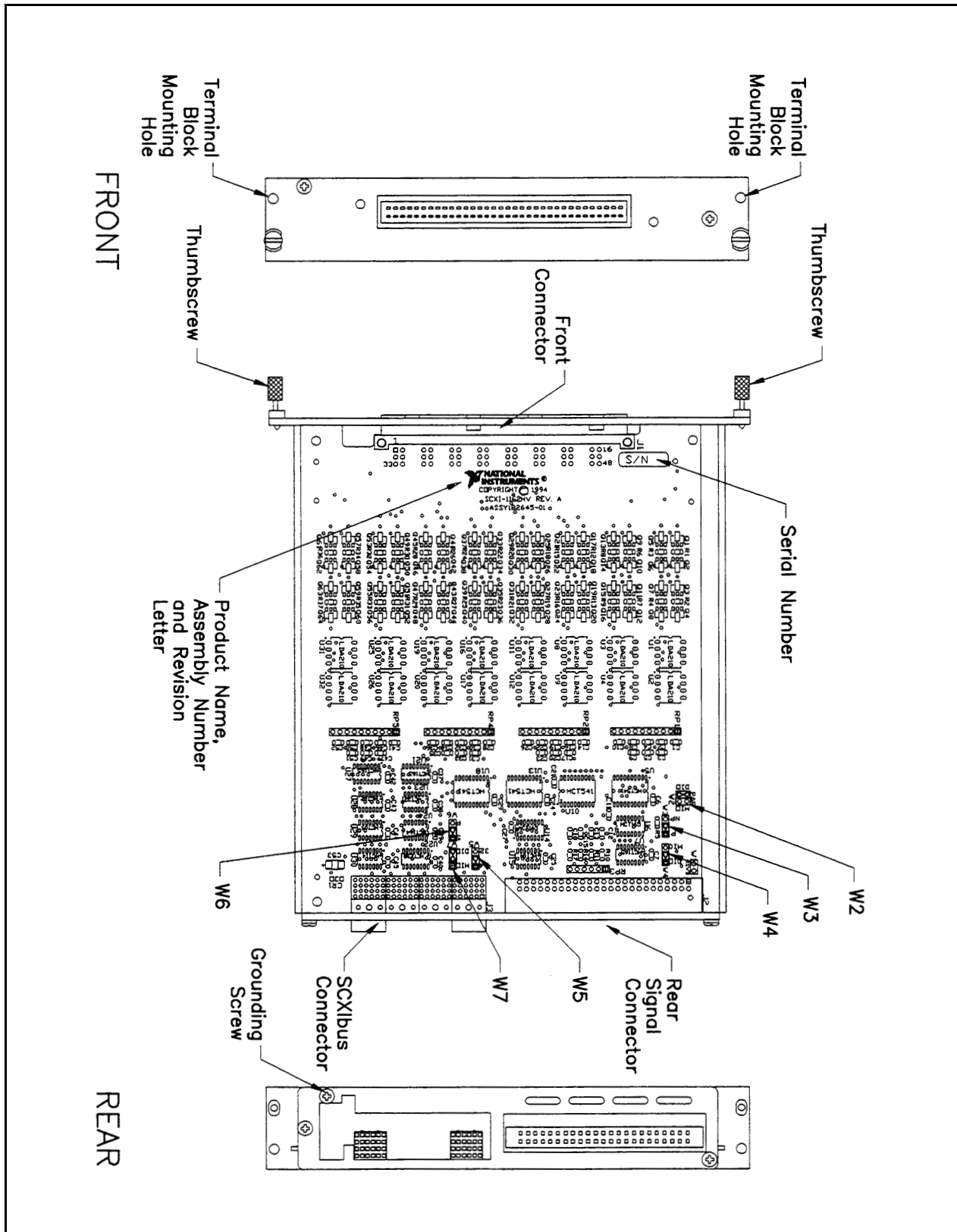

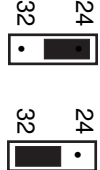

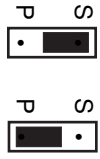

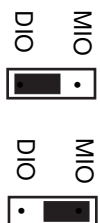
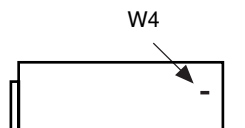
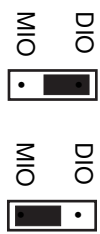

Figure 2-2. SCXI-1162HV Parts Locator Diagram

Table 2-1. Digital Signal Connections, Jumper Settings

| Jumper | Description | Configuration |
|---|--|---|
|  <p>W5</p> | <p>Factory setting—Drives only 24 lines when W2 is set to PAR. Used with DIO-24 or MIO-16D.</p> <p>Drives all 32 rear connector data lines when W2 is set to PAR. Used with DIO-32F or DIO-96.</p> |  |
|  <p>W6</p> | <p>Factory setting—Configures rear connector for serial communication.</p> <p>Configures rear connector for parallel communication. DIO boards only.</p> |  |
|  <p>W7</p> | <p>Factory setting—Configures rear connector for a DIO board.</p> <p>Configures rear connector for an MIO board. Includes MIO Series and Lab Series boards, and PC-LPM-16.</p> |  |
|  <p>W4</p> | <p>Factory setting—Configures rear connector for a DIO board.</p> <p>Configures rear connector for an MIO board. Includes MIO series, Lab series, and PC-LPM-16.</p> |  |

(continues)

Table 2-1. Digital Signal Connections, Jumper Settings (Continued)

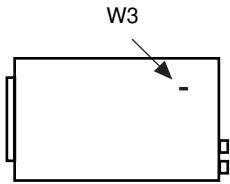
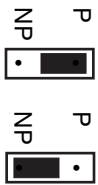
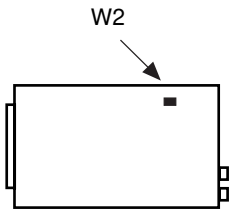
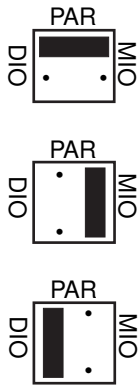
| Jumper | Description | Configuration |
|---|--|--|
|  | <p>Position P (pull-up)—Use this setting for a single-chassis system or for the first chassis in a multichassis system. Connects a pull-up resistor to SERDATOUT. (Factory setting)</p> <p>Position NP (no pull-up)—Use this setting for additional chassis in a multichassis system. No pull-up resistor is connected to SERDATOUT.</p> |  |
|  | <p>Parking position—Disconnects SERDATOUT line. Use for parallel mode.</p> <p>Configures SERDATOUT for MIO-type board. Includes MIO series, Lab series, and PC-LPM-16.</p> <p>Factory setting—Configures SERDATOUT for DIO-type board.</p> |  |

Note: *The shaded area indicates the position of the jumper.*

Supplementary Jumper W3 Configuration Information

Jumper W3, when set to position P, connects a 2.2 kΩ pull-up resistor to the SERDATOUT line. An open-collector driver actively drives low or goes to a high-impedance state, relying on a pull-up resistor to make the signal line go high. If too many pull-up resistors are attached to the SERDATOUT line, the drivers cannot drive the line low. To prevent this, set jumper W3 to position P on only one of the SCXI-1162HVs that are cabled to the DAQ board in a multichassis system. It does not matter which of the SCXI-1162HVs cabled to the DAQ board has the pull-up connected.

Hardware Installation

You can install the SCXI-1162HV in any available SCXI chassis. After you have made any necessary changes and have verified and recorded the jumper settings on the form in Appendix B, *Customer Communication*, you are ready to install the SCXI-1162HV. The following are general installation instructions; consult the user manual or technical reference manual of your SCXI chassis for specific instructions and warnings.

1. Turn off the computer that contains the DAQ board or disconnect it from your SCXI chassis.
2. Turn off the SCXI chassis. Do not insert the SCXI-1162HV into a chassis that is turned on.

3. Insert the SCXI-1162HV into the board guides. Gently guide the module into the back of the slot until the connectors make good contact. If you have already installed a cable assembly in the rear of the chassis, you must firmly engage the module and cable assembly; however, do not *force* the module into place.
4. Screw the front mounting panel of the SCXI-1162HV to the top and bottom threaded strips of your SCXI chassis.
5. If this module is to be connected to an MIO-16 or a DIO-24 DAQ board, attach the connector at the metal end of the SCXI-1340 cable assembly to the rear signal connector on the SCXI-1162HV module. Screw the rear panel to the rear threaded strip. Attach the loose end of the cable to the DAQ board.

Note: *For installation procedures with other SCXI accessories, consult the appropriate installation guides.*

6. Check the installation.
7. Turn on the SCXI chassis.
8. Turn on the computer or reconnect it to your chassis.

The SCXI-1162HV board is installed. You are now ready to install and configure your software.

Software Installation

If you are using NI-DAQ, refer to the *NI-DAQ User Manual for PC Compatibles*. The software installation and configuration instructions are in Chapter 1, *Introduction to NI-DAQ*. Find the installation and system configuration section for your operating system and follow the instructions given there.

If you are using LabVIEW, the software installation instructions are in your LabVIEW release notes. After you have installed LabVIEW, refer to the *Configuring LabVIEW* section of Chapter 1 of your LabVIEW user manual for software configuration instructions.

If you are using LabWindows, the software installation instructions are in Part 1, *Introduction to LabWindows*, of the *Getting Started with LabWindows* manual. After you have installed LabWindows, refer to Chapter 1, *Configuring LabWindows*, of the *LabWindows User Manual* for software configuration instructions.

If you are a register-level programmer, refer to the *SCXI-1162HV Register-Level Programmer Manual*.

Chapter 3

Signal Connections

This chapter describes the SCXI-1162HV signal connections via the front and rear connectors, and has specifications and connection instructions for the SCXI-1162HV connector signals.

The following warnings contain important safety information concerning hazardous voltages.

Warning: *Connections that exceed any of the maximum ratings of input signals on the SCXI-1162HV can damage the SCXI-1162HV board and the SCXIbus. Maximum input ratings for each signal are given in this chapter under the discussion of that signal. National Instruments is not liable for any damages resulting from signal connections that exceed these ratings.*

KEEP AWAY FROM LIVE CIRCUITS. *Do not remove equipment covers or shields unless you are trained to do so. If signal wires are connected to the module or terminal block, dangerous voltages may exist even when the equipment is turned off. To avoid dangerous electrical shock, do not perform procedures involving cover or shield removal unless you are qualified to do so.*

DO NOT OPERATE DAMAGED EQUIPMENT. *The safety protection features built into this module can become impaired if the module becomes damaged in any way. If it is damaged, turn the module off and do not use until service-trained personnel can check its safety. If necessary, return the module to National Instruments for service and repair to ensure that its safety is not compromised.*

DO NOT SUBSTITUTE PARTS OR MODIFY EQUIPMENT. *Because of the danger of introducing additional hazards, do not install unauthorized parts or modify the module. Return the module to National Instruments for service and repair to ensure that its safety features are not compromised.*

When using the terminal block with high common-mode voltages, you MUST insulate your signal wires appropriately. National Instruments is NOT liable for any damages or injuries resulting from inadequate signal wire insulation.

When connecting or disconnecting signal lines to the SCXI-1326 terminal block screw terminals, make sure the lines are powered off to prevent shock hazard.

Connections, including power signals to ground and vice versa, that exceed any of the maximum signal ratings on the SCXI-1162HV can damage any or all of the boards connected to the SCXI chassis, the host computer, and the SCXI-1162HV module. National Instruments is NOT LIABLE FOR ANY DAMAGES OR INJURIES resulting from incorrect signal connections.

If high voltages (≥ 42 Vrms or 60 VDC) are present, YOU MUST CONNECT THE SAFETY EARTH GROUND TO THE STRAIN-RELIEF TAB. This complies with UL 1244 and protects against electric shock when the terminal block is not connected to the chassis. To connect the safety earth ground to the strain-relief tab, run an earth ground wire in the cable from the signal source to the terminal block. National Instruments is NOT liable for any damages or injuries resulting from inadequate safety earth ground connections.

Front Connector

Figure 3-1 shows the pin assignments for the SCXI-1162HV front connector.

| Pin Number | Signal Name | Column | | | Signal Name |
|------------|-------------|--------|---|---|-------------|
| | | A | B | C | |
| 30 | In 0 | | | | NC |
| | In 1 | ○ | ○ | ○ | |
| | In 2 | | | | |
| 29 | In 3 | ○ | ○ | ○ | GND |
| | In 4 | | | | |
| | In 5 | ○ | ○ | ○ | |
| 26 | In 6 | | | | NC |
| | In 7 | ○ | ○ | ○ | |
| | In 8 | | | | |
| 25 | In 9 | ○ | ○ | ○ | GND |
| | In 10 | | | | |
| | In 11 | ○ | ○ | ○ | |
| 22 | In 12 | | | | NC |
| | In 13 | ○ | ○ | ○ | |
| | In 14 | | | | |
| 21 | In 15 | ○ | ○ | ○ | GND |
| | In 16 | | | | |
| | In 17 | ○ | ○ | ○ | |
| 18 | In 18 | | | | NC |
| | In 19 | ○ | ○ | ○ | |
| | In 20 | | | | |
| 17 | In 21 | ○ | ○ | ○ | GND |
| | In 22 | | | | |
| | In 23 | ○ | ○ | ○ | |
| 14 | In 24 | | | | NC |
| | In 25 | ○ | ○ | ○ | |
| | In 26 | | | | |
| 13 | In 27 | ○ | ○ | ○ | GND |
| | In 28 | | | | |
| | In 29 | ○ | ○ | ○ | |
| 10 | In 30 | | | | NC |
| | In 31 | ○ | ○ | ○ | |
| | In 32 | | | | |
| 9 | In 33 | ○ | ○ | ○ | GND |
| | In 34 | | | | |
| | In 35 | ○ | ○ | ○ | |
| 6 | In 36 | | | | NC |
| | In 37 | ○ | ○ | ○ | |
| | In 38 | | | | |
| 5 | In 39 | ○ | ○ | ○ | GND |
| | In 40 | | | | |
| | In 41 | ○ | ○ | ○ | |
| 2 | In 42 | | | | NC |
| | In 43 | ○ | ○ | ○ | |
| | In 44 | | | | |
| 1 | In 45 | ○ | ○ | ○ | GND |
| | In 46 | | | | |
| | In 47 | ○ | ○ | ○ | |

Figure 3-1. SCXI-1162HV Front Connector Pin Assignment

Front Connector Signal Descriptions

| Pin | Signal | Description |
|---|------------------|---|
| B30, A30, B29, A29, C29 | In <0..3>, GND | Bank 0 input channels and ground reference. |
| B26, A26, B25, A25, C25 | In <4..7>, GND | Bank 1 input channels and ground reference. |
| B22, A22, B21, A21, C21 | In <8..11>, GND | Bank 2 input channels and ground reference. |
| B18, A18, B17, A17, C17 | In <12..15>, GND | Bank 3 input channels and ground reference. |
| A13, B13, A14, B14, C14 | In <16..19>, GND | Bank 4 input channels and ground reference. |
| A9, B9, A10, B10, C10 | In <20..23>, GND | Bank 5 input channels and ground reference. |
| A5, B5, A6, B6, C6 | In <24..27>, GND | Bank 6 input channels and ground reference. |
| A1, B1, A2, B2, C2 | In <28..32>, GND | Bank 7 input channels and ground reference. |
| C1, C5, C9, C13, C18, C22, C26, C30 | NC (No Connect) | Unused pins. |

Input Channels

The optically isolated inputs of the SCXI-1162HV consist of bidirectional light-emitting diodes and current-limiting circuitry. The SCXI-1162HV has eight banks of four of these optically isolated inputs. Each bank of inputs has a separate connection for the ground reference (GND) for that bank. The four inputs of each bank are referenced to the GND of that bank, so for any bank of inputs to work, a GND *must* be connected to that bank. When a voltage is applied between an input and its ground, signal current flows through the input and the diode emits light that is sensed by a photosensitive circuit. When this circuit senses the light, it returns a logic-high digital signal.

Sensing DC Voltages

When a positive or negative DC voltage with a magnitude of at least 2 V is referenced to the GND of a bank and is applied to an input of that bank, the SCXI-1162HV registers a logic high for that input. Current-limiting circuitry limits the input current to 1.5 mA for input voltages up to 240 VDC referenced to the GND signal. If there is no such voltage, the SCXI-1162HV will register a logic low for that input. Thus, you can use the SCXI-1162HV to sense the presence of a wide range of DC signals; from digital logic levels to DC power supply levels up to 240 V.

There is a delay of approximately 1 ms between the time a voltage is removed and the time the SCXI-1162HV recognizes this change.

Sensing AC Voltages

The SCXI-1162HV senses a wide range of AC signals by registering a constant logic high while an AC voltage (referenced to a GND) is present at an input. Signals with low amplitude and low frequency appear as signals that are alternately turned on and off; therefore the module alternately registers logic highs and logic lows for that signal. For sinusoidal signals, a 50 or 60 Hz signal with a voltage of at least 20 Vrms returns a constant logic high level. For 1 kHz and higher frequency signals, a 2 Vrms signal returns a constant logic high level.

The current-limiting circuitry limits the current to 1.5 mA for input voltages up to 240 Vrms for a sinusoidal signal.

Signal Isolation

The GND and inputs of each bank are isolated from the GND and inputs of any other bank. In addition, all signals are isolated from the chassis earth ground and the internal circuitry of the module. These barriers provide isolation for voltages up to 450 VAC or VDC and protect the user and the SCXI system. *There is no isolation between signals of the same bank.* You must not exceed the voltage limits of the inputs referenced to their respective GND signals.

Signal Connection Example

In Figure 3-2, one channel of the SCXI-1162HV is being used to sense that a load is being powered. The load is connected to a power supply by means of a switch. This power supply can be AC or DC and can be any voltage within the SCXI-1162HV range. Common supplies may include +5 VDC, -48 VDC, or 120 VAC 60 Hz. When the switch is open, no current flows through the load and no voltage is applied to the load or to the SCXI-1162HV input. The digital logic of the SCXI-1162HV then registers a logic low or 0 for the channel. When the switch is closed, the power supply voltage is applied across both the load and the input, and the SCXI-1162HV registers a logic high or 1 for the channel.

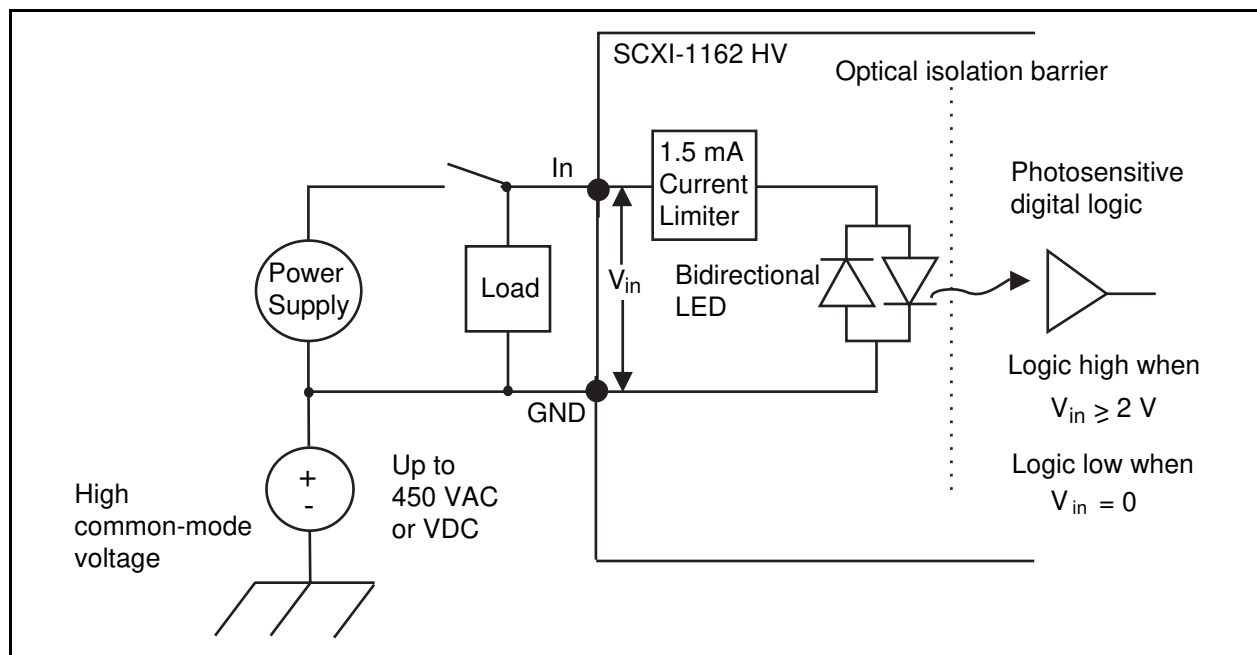

Figure 3-2. Signal Connection Example

Terminal Block

The SCXI-1326 terminal block has screw terminals for easy signal connection to the SCXI-1162HV inputs. This kit is listed in the *Optional Equipment* section in Chapter 1, *Introduction*. See the *SCXI-1326 Terminal Block Installation Guide* for more information on connecting it to your SCXI-1162HV.

Rear Signal Connector

Note: *If you are using the SCXI-1162HV with a National Instruments DAQ board and cable assembly, you do not need to read the remainder of this chapter. If you are using the SCXI-1180 feedthrough panel, the SCXI-1343 rear screw terminal adapter, or the SCXI-1351 one-slot cable extender with the SCXI-1162HV, read this section.*

The rear signal connector is configured based on the jumper settings described earlier in this chapter. Figure 3-3A shows the pin assignments for the SCXI-1162HV rear signal connector configured for serial communication. Figure 3-3B shows the pin assignments for the SCXI-1162HV rear signal connector configured for parallel communication.

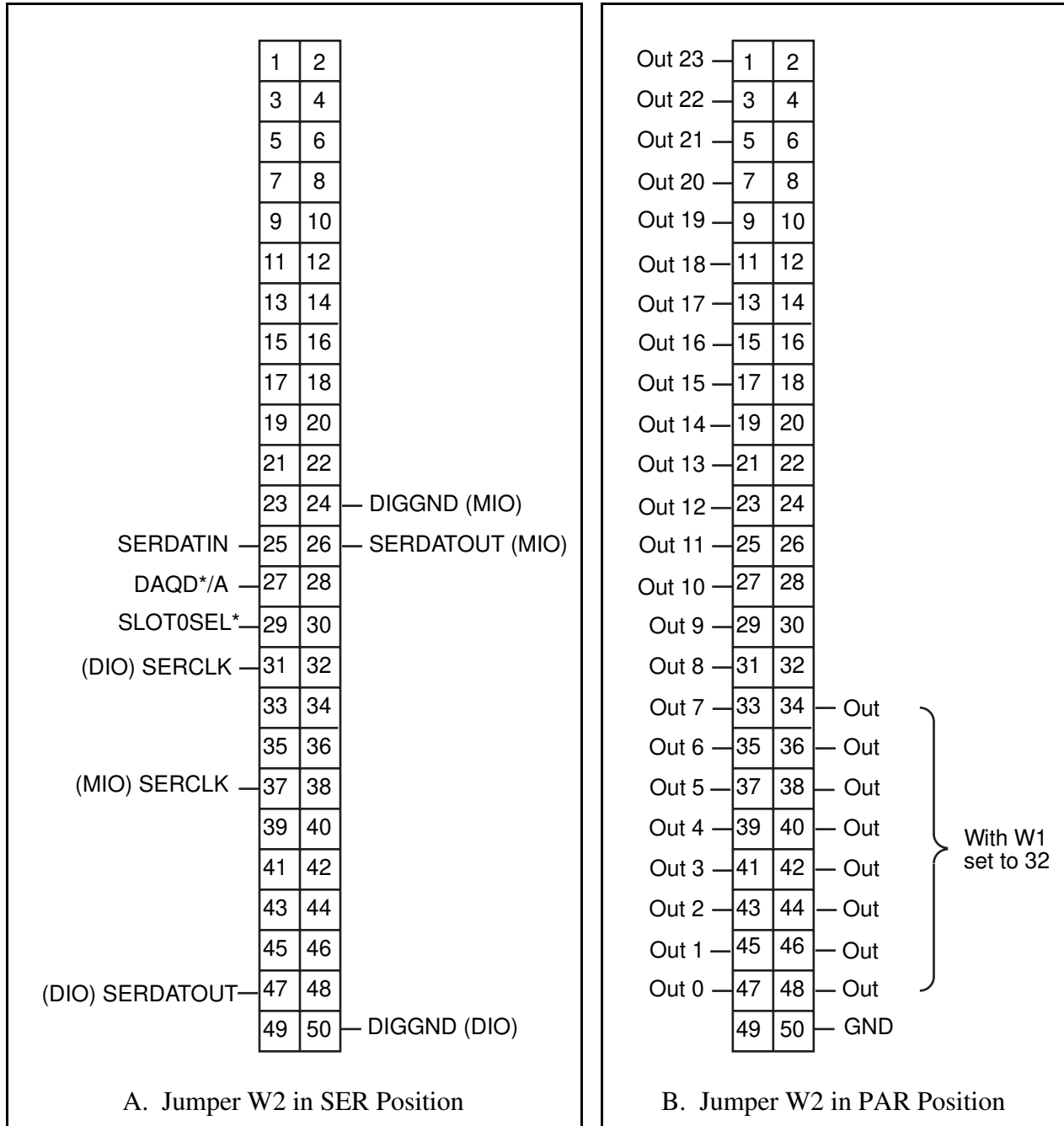

Figure 3-3. SCXI-1162HV Rear Signal Connector Pin Assignments

Rear Signal Connector Signal Descriptions, Serial Configuration

| Pin | Signal | Description |
|----------|-----------|--|
| 24 or 50 | DIGGND | Digital Ground—Supplies the reference for DAQ board digital signals and is tied to the module digital ground. Pin 50 is for DIO boards. Pin 24 is for MIO boards and jumper W4 selects it. |
| 25 | SERDATIN | Serial Data In—Taps into the SCXIBus MOSI line to provide serial input data to a module or Slot 0. |
| 26 or 47 | SERDATOUT | Serial Data Out—Taps into the SCXIBus MISO line to accept serial output data from a module. Pin 47 is for DIO boards. Pin 26 is for MIO boards and jumper W6 selects it. |
| 27 | DAQD*/A | DAQ Board Data/Address Line—Taps into the SCXIBus D*/A line to indicate to the module whether the incoming serial stream is data or address information. |
| 29 | SLOT0SEL* | Slot 0 Select—Taps into the SCXIBus INTR* line to indicate whether the information on MOSI is sent to a module or to Slot 0. |
| 31 or 37 | SERCLK | Serial Clock—Taps into the SCXIBus SPICLK line to clock the data on the MOSI and MISO lines. Pin 31 is for DIO boards. Pin 37 is for MIO boards and jumper W3 selects it. |

* Indicates active low.

All other pins are not connected.

See Chapter 2, *Timing*, of the *SCXI-1162HV Register-Level Programmer Manual* for information on serial communication and programming.

Rear Signal Connector Signal Descriptions, Parallel Configuration

| Pin | Signal | Description |
|--|--------------|---|
| 1, 3, 5, 7, 9, 11, 13, 15, 17, 19, 21, 23, 25, 27, 29, 31, 33, 35, 37, 39, 41, 43, 45, 47 | Out <23..0> | Parallel outputs driven to the logic levels seen at inputs 23 through 0. |
| 34, 36, 38, 40, 42, 44, 46, 48 | Out <31..24> | Parallel outputs driven to the logic levels seen at inputs 31 through 24 when jumper W1 is set to 32. |
| 50 | GND | Ground—Supplies ground reference for the parallel outputs. |

All other pins are not connected.

The following specifications apply to the digital output lines (referenced to DIGGND):

- V_{OH} output logic high voltage 3.7 V min at 4 mA max
- V_{OL} output logic low voltage 0.4 V max at 4 mA max

Appendix A

Specifications

This appendix lists the specifications of the SCXI-1162HV. These specifications are typical at 25° C unless otherwise noted.

Number of channels 32 organized into 8 optically isolated banks of 4 inputs each

Digital logic levels

| Level | Min | Max |
|--------------------------------------|--------|----------|
| Input low voltage (DC or Peak AC) | — | ±1 V |
| Input high voltage | | |
| DC | ±2 VDC | ±240 VDC |
| 50–60 Hz AC | 10 VAC | 240 VAC |
| 1 kHz AC | 2 VAC | 240 VAC |

(VAC assumes sinusoidal waveforms)

Input current limiting 1 mA

Common-mode isolation,

 bank-to-bank and bank-to-ground

 Working 450 V_{rms} max

Common-mode rejection 500 V/μs typ

Maximum speed

 Propagation delay, parallel mode

 (V_{cc} = 5 V) 1.5 ms

 Serial data rate 1,000 words/s¹

Physical

Dimensions 1.2 by 6.8 in. by 8.0 in. (33.78 by 9.91 cm)

I/O connector 50-pin male ribbon-cable rear connector

48-pin DIN C male front connector

(SCXI-1326 screw terminal adapter available)

Environment

Operating temperature 0° to 50° C

Storage temperature -40° to 125° C

Relative humidity 5% to 90% noncondensing

¹ Transfer rate depends on the computer and software. These tests were made using a 50 MHz 80486 computer running NI-DAQ software.

Appendix B

Customer Communication

For your convenience, this appendix contains forms to help you gather the information necessary to help us solve technical problems you might have as well as a form you can use to comment on the product documentation. Filling out a copy of the *Technical Support Form* before contacting National Instruments helps us help you better and faster.

National Instruments provides comprehensive technical assistance around the world. In the U.S. and Canada, applications engineers are available Monday through Friday from 8:00 a.m. to 6:00 p.m. (central time). In other countries, contact the nearest branch office. You may fax questions to us at any time.

Corporate Headquarters

(512) 795-8248

Technical support fax: (800) 328-2203
(512) 794-5678

| Branch Offices | Phone Number | Fax Number |
|-----------------------|---------------------|-------------------|
| Australia | (03) 879 9422 | (03) 879 9179 |
| Austria | (0662) 435986 | (0662) 437010-19 |
| Belgium | 02/757.00.20 | 02/757.03.11 |
| Denmark | 45 76 26 00 | 45 76 71 11 |
| Finland | (90) 527 2321 | (90) 502 2930 |
| France | (1) 48 14 24 00 | (1) 48 14 24 14 |
| Germany | 089/741 31 30 | 089/714 60 35 |
| Italy | 02/48301892 | 02/48301915 |
| Japan | (03) 3788-1921 | (03) 3788-1923 |
| Netherlands | 03480-33466 | 03480-30673 |
| Norway | 32-848400 | 32-848600 |
| Spain | (91) 640 0085 | (91) 640 0533 |
| Sweden | 08-730 49 70 | 08-730 43 70 |
| Switzerland | 056/20 51 51 | 056/20 51 55 |
| U.K. | 0635 523545 | 0635 523154 |

Technical Support Form

Photocopy this form and update it each time you make changes to your software or hardware, and use the completed copy of this form as a reference for your current configuration. Completing this form accurately before contacting National Instruments for technical support helps our applications engineers answer your questions more efficiently.

If you are using any National Instruments hardware or software products related to this problem, include the configuration forms from their user manuals. Include additional pages if necessary.

Name _____

Company _____

Address _____

Fax (____) _____ Phone (____) _____

Computer brand _____ Model _____ Processor _____

Operating system _____

Speed _____MHz RAM _____MB Display adapter _____

Mouse _____yes _____no Other adapters installed _____

Hard disk capacity _____MB Brand _____

Instruments used _____

National Instruments hardware product model _____ Revision _____

Configuration _____

National Instruments software product _____ Version _____

Configuration _____

The problem is _____











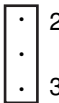

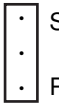
List any error messages _____

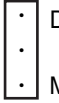
The following steps will reproduce the problem _____

SCXI-1162HV Hardware Configuration Form

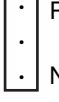
Record the settings and revisions of your hardware and software on the line to the right of each item. Complete a new copy of this form each time you revise your software or hardware configuration, and use this form as a reference for your current configuration. Completing this form accurately before contacting National Instruments for technical support helps our applications engineers answer your questions more efficiently.

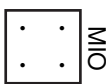
- SCXI-1162HV Revision _____
- Chassis Slot _____
- Chassis Type _____

| | My Setting | Factory Setting |
|-------------|---|---|
| • Jumper W1 |  |  |
| • Jumper W2 |  |  |
| • Jumper W3 |  |  |
| • Jumper W4 |  |  |
| • Jumper W5 |  |  |
| • Jumper W6 |  |  |

Note: *Mark your jumper positions on the jumper diagrams in the left column.*

- Other Modules and Chassis in System _____
- DAQ Boards Installed _____

Register-Level Programmer Manual Request Form

National Instruments offers a register-level programmer manual at no charge to customers who are not using National Instruments software.

Title: **SCXI-1162HV Register-Level Programmer Manual**

Part Number: **340735A-01**

Please indicate your reasons for obtaining the register-level programmer manual. Check all that apply.

- National Instruments does not support your operating system or programming language.
- You are an experienced register-level programmer who is more comfortable writing your own register-level software.
- Other. Please explain.

Thank you for your help.

Name _____

Title _____

Company _____

Shipping Address _____

(Street Address, Not P.O. Box) _____

Phone (_____) _____

Mail to: Data Entry Department
National Instruments Corporation
6504 Bridge Point Parkway
Austin, TX 78730-5039

Fax to: Data Entry Department
National Instruments Corporation
(512) 794-8411

Documentation Comment Form

National Instruments encourages you to comment on the documentation supplied with our products. This information helps us provide quality products to meet your needs.

Title: **SCXI-1162HV User Manual**

Edition Date: **August 1994**

Part Number: **320790A-01**

Please comment on the completeness, clarity, and organization of the manual.

If you find errors in the manual, please record the page numbers and describe the errors.

Thank you for your help.

Name _____

Title _____

Company _____

Address _____

Phone (_____) _____

Mail to: Technical Publications
National Instruments Corporation
6504 Bridge Point Parkway, MS 53-02
Austin, TX 78730-5039

Fax to: Technical Publications
National Instruments Corporation
MS 53-02
(512) 794-5678

Glossary

| Prefix | Meaning | Value |
|--------|---------|-------------------|
| p- | pico- | 10 ⁻¹² |
| n- | nano- | 10 ⁻⁹ |
| μ- | micro- | 10 ⁻⁶ |
| m- | milli- | 10 ⁻³ |
| k- | kilo- | 10 ³ |
| M- | mega- | 10 ⁶ |

| | |
|------------------|-----------------------------|
| +5 V | +5 VDC Source signal |
| ° | degrees |
| Ω | ohms |
| A | amperes |
| ADC | A/D converter |
| Arms | amperes, root mean square |
| AWG | American Wire Gauge |
| BCD | binary-coded decimal |
| C | Celsius |
| CHS | Chassis bit |
| CMRR | common-mode rejection ratio |
| dB | decibels |
| DIN | Deutsche Industrie Norme |
| DMM | digital multimeter |
| F | farads |
| FIFO | first-in-first-out |
| ft | feet |
| GND | ground signal |
| hex | hexadecimal |
| Hz | hertz |
| I _I | input current leakage |
| I _{in} | input current |
| I/O | input/output |
| I _{out} | output current |
| in. | inches |
| IN | Input bit |
| INTR* | Interrupt signal |
| ksamples | 1,000 samples |
| LSB | least significant bit |
| m | meters |
| MB | megabytes of memory |
| MSB | most significant bit |

Glossary

| | |
|------------------|---|
| Out <23..0> | Parallel outputs driven to the logic levels seen at inputs 23 through 0. |
| Out <31..24> | Parallel outputs driven to the logic levels seen at inputs 31 through 24 when jumper W1 is set to 32. |
| ppm | parts per million |
| RAM | random-access memory |
| rms | root mean square |
| s | seconds |
| SPDT | single-pole double throw |
| SPI | serial peripheral interface |
| SS* | Slot Select signal |
| UL | Underwriters Laboratory |
| V | volts |
| VAC | volts alternating current |
| V _{cc} | positive supply voltage |
| VDC | volts direct current |
| V _{IH} | volts input high |
| V _{IL} | volts input low |
| V _{in} | volts in |
| V _{OH} | volts output high |
| V _{OL} | volts output low |
| V _{out} | volts out |
| V _{rms} | volts, root mean square |
| W | watts |

Index

A

AC voltages, 3-5

C

cables, custom, 1-5 to 1-6
configuration. *See also* installation.
 connection to MIO-type or DIO-type
 DAQ boards, 2-1
 factory configuration, 2-1
 jumpers
 parts locator diagram, 2-4
 procedure for changing jumpers, 2-3
 rear signal connector, 3-6
 supplementary W3
 configuration, 2-6
 W2 and W3 jumper configuration
 for DIO- and MIO-type boards
 (table), 2-6
 W4, W5, W6, and W7 jumper
 configuration for DIO- and
 MIO-type boards (table), 2-5
 options, 2-1
 parallel mode operation, 2-2
 serial mode operation, 2-2
custom cables, 1-5 to 1-6
customer communication, *x*, B-1

D

DAQD*/A signal (table), 3-8
DC voltages, 3-4
DIGGND signal (table), 3-8
documentation
 conventions used in manual, *vii*
 customer communication, *x*
 National Instruments documentation
 set, *ix*
 organization of this manual, *vii*
 related documentation, *ix*

E

electrical hazards (warning), 3-1
environment specifications, A-1
equipment, optional, 1-4 to 1-5

F

front connector
 optically isolated solid-state relay
 channels, 3-4
 pin assignments (illustration), 3-3
 signal descriptions (table), 3-4
 input channels, 3-4
 sensing AC voltages, 3-5
 sensing DC voltages, 3-4
 signal connection example, 3-5
 to 3-6
 signal isolation, 3-5

G

GND signal (table), 3-9

H

hardware installation, 2-6 to 2-7

I

input channels, 3-4
installation. *See also* configuration.
 hardware installation, 2-6 to 2-7
 SCXI-1326 terminal block, 3-6 to 3-7
 software installation, 2-7
 unpacking the SCXI-1162HV, 1-6

J

jumpers

- parts locator diagram, 2-4
- procedure for changing jumpers, 2-3
- rear signal connector, 3-7
- supplementary W3 configuration, 2-6
- use, 2-3
- W2 and W3 jumper configuration for DIO- and MIO-type boards (table), 2-6
- W4, W5, W6, and W7 jumper configuration for DIO- and MIO-type boards (table), 2-5

L

LabVIEW and LabWindows software, 1-2

M

manual. *See* documentation.
module, configuration, 2-1

N

NI-DAQ driver software, 1-2 to 1-3

P

parallel mode operation, 2-1 to 2-2
parts locator diagram, 2-4
physical specifications, A-1
pin assignments

- front connector (illustration), 3-3
- rear signal connector (illustration), 3-7

R

rear signal connector, 3-6 to 3-9

- configuration, 3-6
 - parallel mode, 2-2
 - serial mode, 2-2
- pin assignments (illustration), 3-7

signal descriptions

- parallel configuration (table), 3-9
- serial configuration (table), 3-8

register-level programming, 1-4

S

SCXI-1162HV

- capabilities, 1-1
- custom cables, 1-5 to 1-6
- kit contents, 1-1
- optional equipment, 1-4 to 1-5
- software programming choices, 1-1 to 1-3
 - LabVIEW and LabWindows software, 1-2
 - NI-DAQ driver software, 1-2 to 1-3
 - register-level programming, 1-4
- unpacking, 1-6

SCXI-1326 terminal block, 3-5

SERCLK signal (table), 3-8

SERDATIN signal (table), 3-8

SERDATOUT signal (table), 3-8

serial mode operation, 2-2

signal connections

- electrical hazards (warning), 3-1
- front connector
 - pin assignments (illustration), 3-3
 - signal descriptions (table), 3-4
 - input channels, 3-4
 - sensing AC voltages, 3-5
 - sensing DC voltages, 3-4
 - signal connection example, 3-5 to 3-6
 - signal isolation, 3-5
- rear signal connector, 3-6 to 3-9
 - configuration, 3-6
 - pin assignments (illustration), 3-7
 - signal descriptions
 - parallel configuration (table), 3-9
 - serial configuration (table), 3-8
- terminal block, 3-6

SLOT0SEL* signal (table), 3-8

software programming choices, 1-1 to 1-3

- LabVIEW and LabWindows software, 1-2 to 1-3
- NI-DAQ driver software, 1-2 to 1-3

register-level programming, 1-4

specifications
 environment, A-1
 physical, A-1

T

technical support, B-1
terminal block, 3-6

U

unpacking the SCXI-1162HV, 1-6